



# Automationpro Ltd.

Industrial Automation



# Key Information

- **Founded 2008 for the design and production of factory automation**
- **Highly qualified engineers**
- **Extensive long year experience**
- **Modern technical solutions**
- **Mechanical CAD – SolidWorks**
- **ePlan for electrical design and documentation**



# Experience

## **Assembly automation including:**

- **handling**
- **assembly**
- **welding**
- **laser processing**
- **vision recognition**
- **traceability**





## Photovoltaic Panel Flip Module



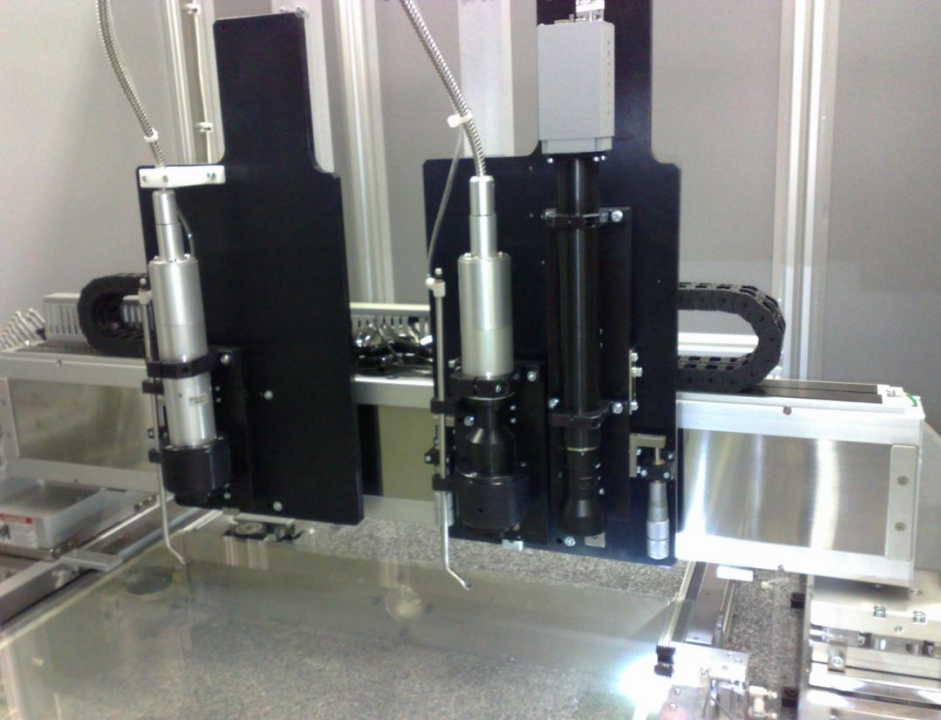



## Thin Film Laser Scribing Machines







# Laboratory Thin Film Laser Scribing Machine



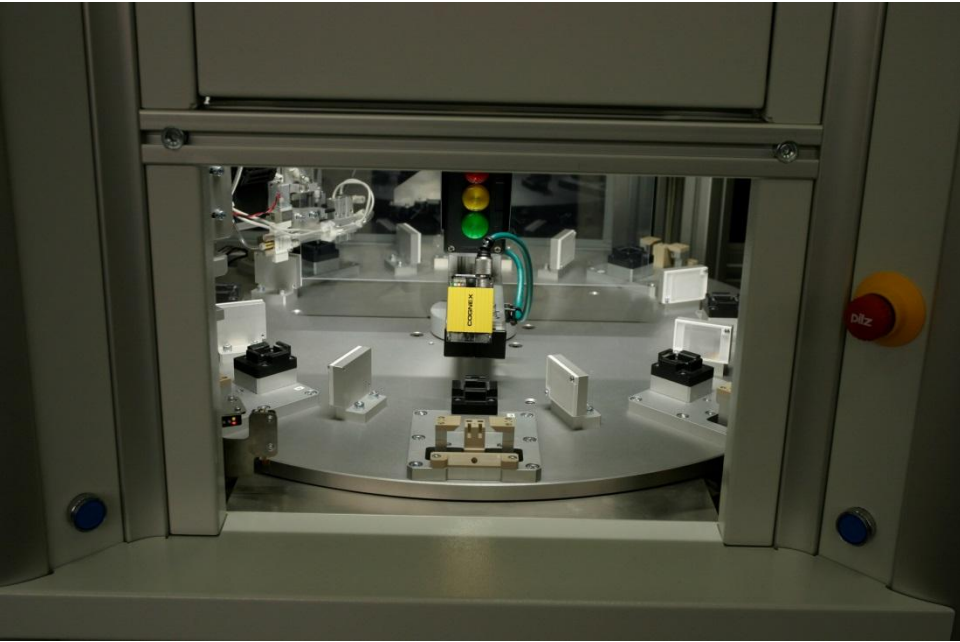



## Automatic Assembly, Test, and Laser Mark Machine

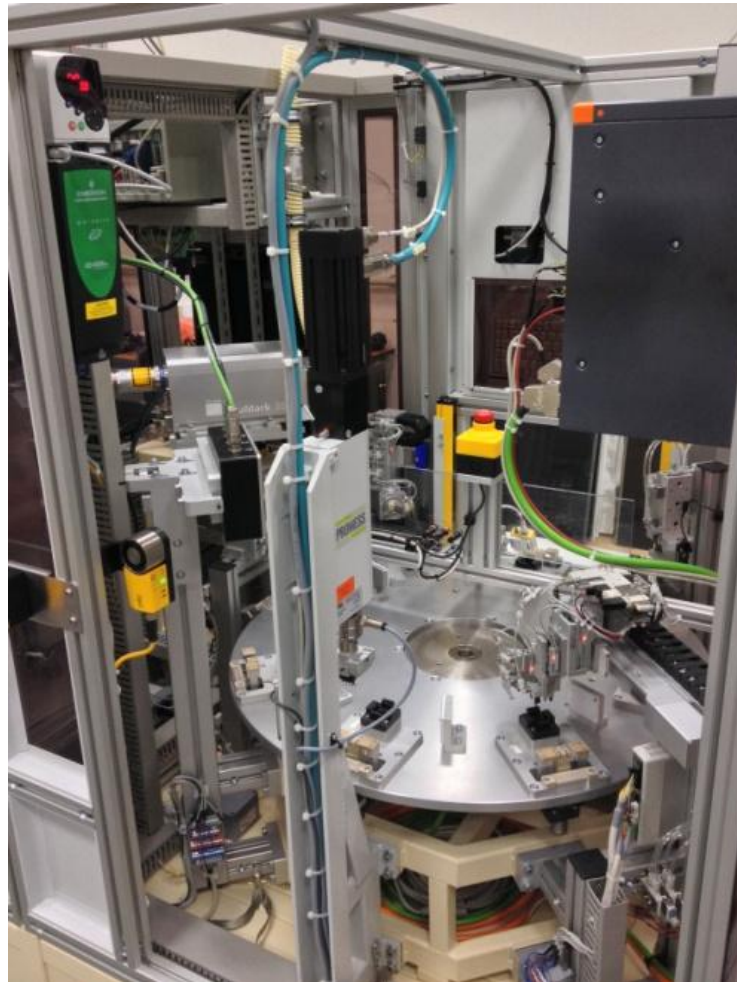

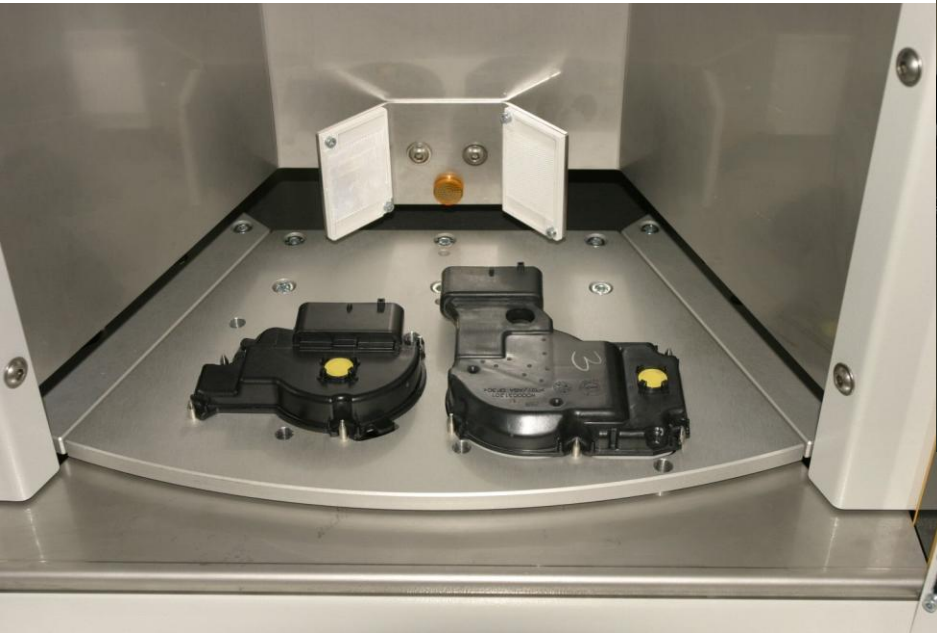

## Assembly and Test Machine



## Laser Marking Machine





# Assembly machine

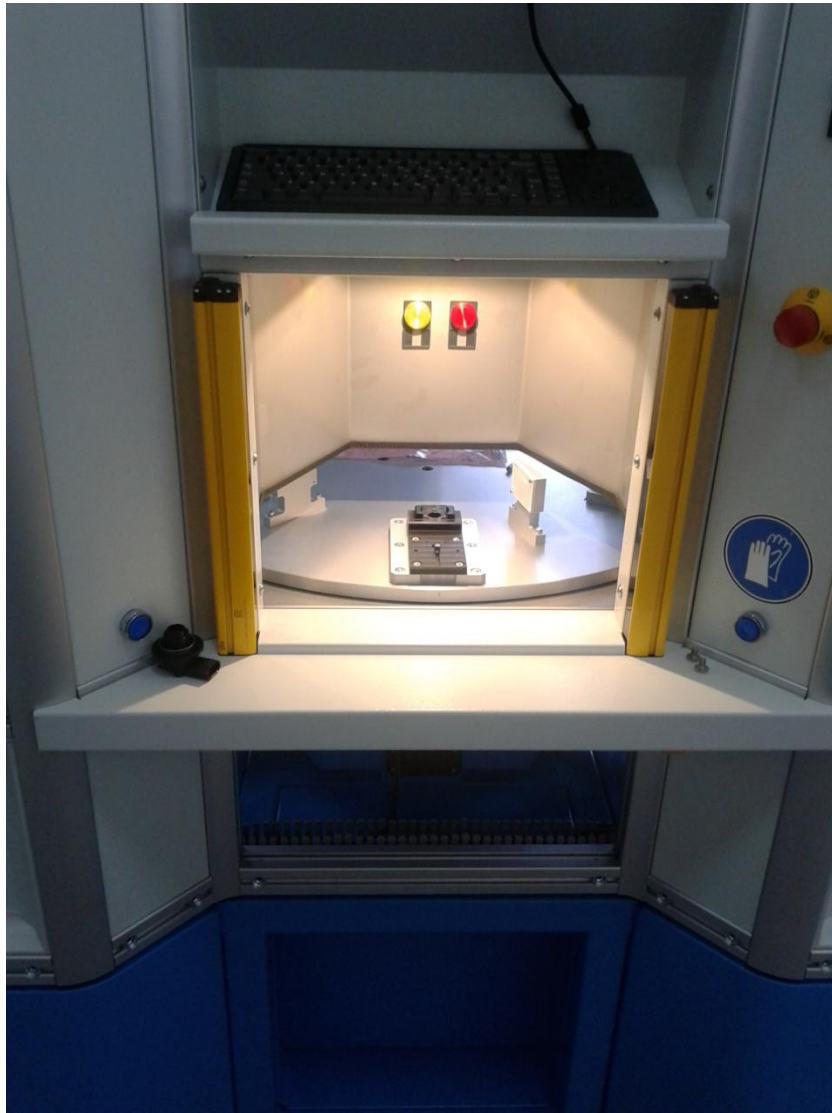



# Process Conveyors

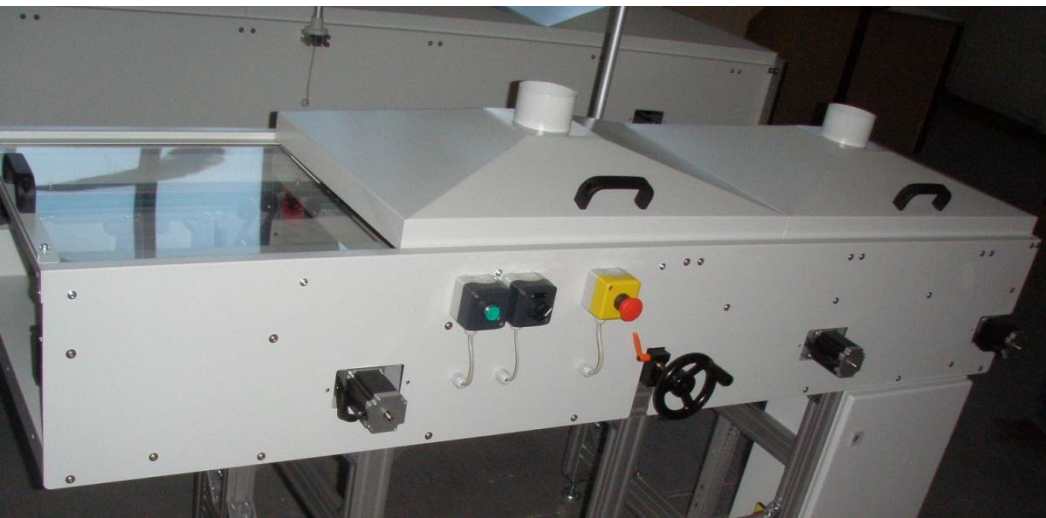
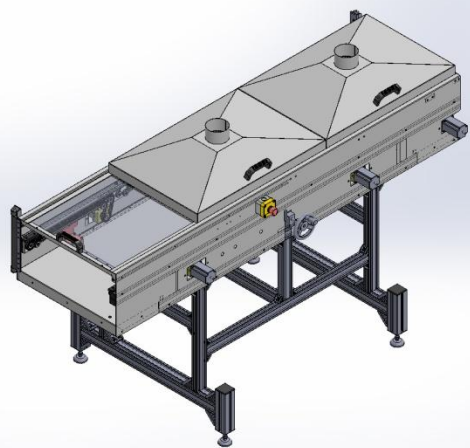



# Splash Water Environmental Tester







# Water Jet Environmental Tester

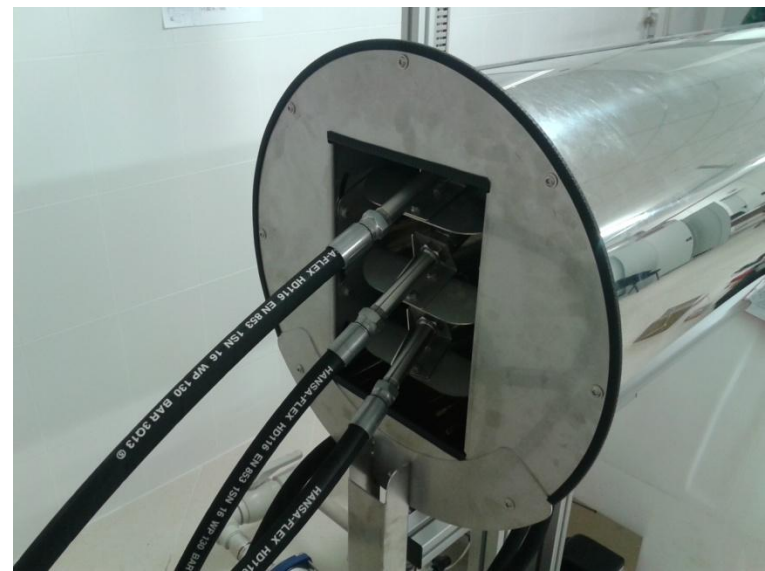



## High Pressure Water Tester



